

**330R**



**330R**

**1/8 DIN PROCESS MONITOR and  
INDICATOR USER'S MANUAL**



The 330 Process Monitor is an entirely new design. The operation of the instrument's keys and the wiring of the rear terminals is different than found on the 320. In addition, a 320 chassis may not be used in a 330 case. To insure proper use and installation, please review the manual before using.

<b>ABOUT THE 330 MONITOR .....</b>	<b>2</b>
<b>SAFETY .....</b>	<b>2</b>
<b>ORDERING .....</b>	<b>3</b>
<b>MOUNTING .....</b>	<b>3</b>
<b>WIRING PRACTICES.....</b>	<b>4</b>
Rear Terminal Connections .....	5
Mechanical Relays (Alarm 1 or 2) .....	5
Relay Contact Wiring .....	5
SSR Drive Output Wiring (Alarm 2) .....	5
Communications Wiring .....	6
Thermocouple Input Wiring .....	6
RTD Input Wiring .....	7
Voltage/Current Input Wiring .....	7
Voltage/Current Input Operation .....	8
PV Display .....	8
<b>HARDWARE SET UP .....</b>	<b>9</b>
Adding or Changing Output Boards or Output Modules .....	10
<b>330 DISPLAY-MODES .....</b>	<b>11</b>
<b>CONFIGURATION .....</b>	<b>12</b>
<b>OPERATION .....</b>	<b>17</b>
Operator Interface .....	17
Peak/Valley Values .....	17
Alarm Operation .....	18
Alarm Operation Charts .....	19
Input Linearization .....	20
Square Root .....	21
Custom Linearization .....	21
Security .....	22
<b>TROUBLESHOOTING/SERVICE .....</b>	<b>23</b>
Symptom/Cause/Solution .....	23
Error messages .....	23
Electrical Noise Solution .....	24
<b>SPECIFICATIONS .....</b>	<b>24</b>

## About This Manual

This product manual contains instructions for the 330 Series Process Monitor. Your instrument model number is listed on the product label (on the top of the instrument case).

## About the 330 Process Monitor

The 330 series Process Monitors are 1/8 DIN four digit display multifunction microcontroller-based instruments. They can function as a panel meter, single or dual trip and analog transmitter. They can also function as digital transmitters with the RS 485 communications port.

330 instruments are user scaleable, which greatly simplifies ordering, setup and stocking. The standard trip function serves as a useful process safety device. User scaleable 0-20mA, 4-20mA, 20-0mA, or 20-4mA transmission is available in the 330. Loop power supply on voltage/current instruments saves on expense and installation complexity when using two wire transmitters, and optional 10 volt excitation simplifies strain gage inputs.

Input types are universal thermocouple (types T, J, K, R, S, N, E, B, W(G), W5(C), and Platinel II), RTD (100 ohm platinum, 1° and 0.1° resolution, JIS and DIN) and voltage/current (4 to 20mA, 0 to 20mA, 1 to 5V, 0 to 5V, -30 to 30mV, 0 to 30mV, 0 to 60mV, and 0 to 100mV). Temperature inputs include selectable °C, °F or °K readout. RTD input includes selectable wide range (-328 to 1562°F) or narrow range (-328.0 to 545.0°F). Voltage/current input includes selectable decimal places.

The front panel with sturdy rubber keys meets NEMA 4X requirements, allowing the instrument to resist moisture and other adverse environmental conditions.

Optional isolated RS 485 serial communications allows supervision and data acquisition by higher level devices. The communications protocol is compatible with all Moore Industries' micro-based instruments, allowing a variety of instruments to be installed on the same RS 485 line.

## Safety

### Warning

This monitor must be properly installed and used. If it is not, it will not perform the function for which it was designed. Improper installation could result in loss or damage to products or equipment, or could endanger plant personnel.

**Read the manual before installing the monitor.**

**Disconnect before servicing.**

## Ordering

Standard Configurations		
•	One Alarm Output (5 Amp Mechanical Relay)	330R0000
•	Two Alarm Outputs (5 Amp Mechanical Relays)	
	One Retransmission (Milliamp) or Loop power Output	330RD000
•	Two Alarm Outputs (5 Amp Mechanical Relay)	
	One Retransmission (Milliamp) or Loop Power Output	
	RS-485 Communications	330RD00X

Field-Upgradable Modular Output Configuration		
<b>Alarm Output:</b>	5 Amp Mechanical Relay (standard)	<input type="checkbox"/> 3 <input type="checkbox"/> R <input type="checkbox"/>
<b>Option Board:</b>	Loop Power _____	<b>Order Code</b> <b>A</b>
	Loop Power and Digital Input _____	<b>B</b>
	10 Volt Excitation and Digital Input _____	<b>C</b>
<b>Option Board Modules:</b>		
<b>Analog Output:</b>	Loop Power #2 _____	<b>L</b>
	Retransmission (Milliamp) _____	<b>M</b>
	None _____	<b>0</b>
<b>Second Alarm Output:</b>	5 Amp Mechanical Relay _____	<b>R</b>
	1 Amp Solid State Relay (Triac) _____	<b>S</b>
	DC Logic (SSR Drive) _____	<b>T</b>
	None _____	<b>0</b>
<b>Serial Communications:</b>	RS-485 Communications _____	<b>X</b>
	None _____	<b>0</b>

## Mounting

The 330 is designed to be panel or cabinet mounted into a 43.7 x 90.5 mm (1.72 X 3.56 in) opening, for maximum sealing between the bezel and the panel. The instrument can be mounted in a standard 1/8 DIN cutout (92mm x 45 mm), but a smaller cutout will provide a snugger fit. Dimensions required for installing the 330 are shown below. With the mounting brackets removed, slide the 330 into the cutout. Install the mounting brackets by pressing the runners of the brackets into the grooves on the case housing. Turning clockwise, tighten the screws on the brackets until they are firm against the mounting panel. Be careful not to overtighten!

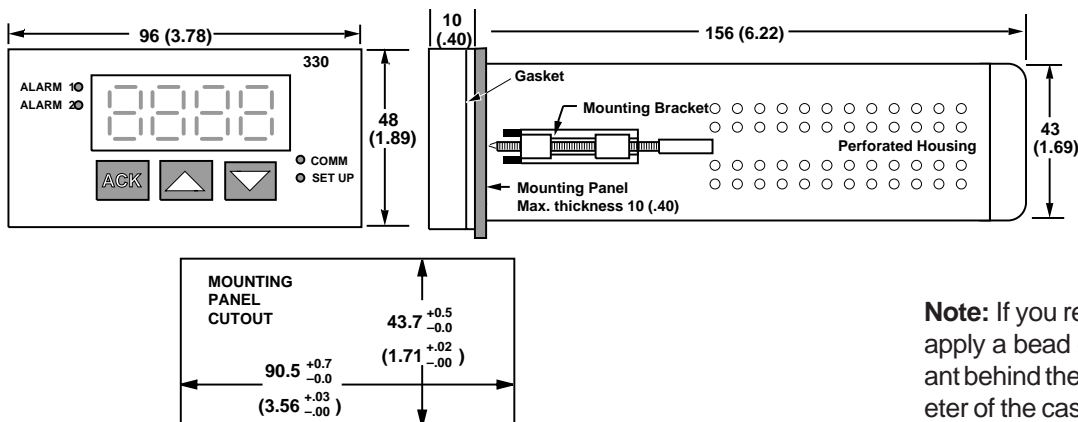

**Note:** If you require a waterproof seal, apply a bead of caulk or silicone sealant behind the panel around the perimeter of the case.

## Wiring Practices

The 330 Monitor blocks out most electrical noise through its filtering circuitry. Without protection, such noise could upset the monitor's normal operation and display readout. To further minimize the risk of noise interference, the 330 should be mounted as far as possible from large electric motors, motor starters, speed controllers, switching equipment and welders.

Certain precautions and guidelines are recommended to ensure safe, reliable operation. The following five points outline common instrumentation wiring practices:

1. Use clean AC power for the instrument power source, either isolated or significantly filtered from any AC switched loads. In other words, the relay internal to the instrument should not derive its power directly from the AC power terminal of the instrument. Use a 0.5 amp, 250 VAC fast-acting fuse connected in series with terminal 1. When wiring to 240VAC, use a second 0.5 amp, 250VAC fast-acting fuse in series with terminal 2.
2. Use surge suppression across switched AC loads at the load and across the contact, such as metal oxide varistors (MOV's) and R-C snubbers, when the switching relay is internal to the instrument and/or when the switched load derives its power from the same main as the instrument power. R-C snubbers should be placed across smaller relay or solenoid coils, or other small inductive loads (0.25 amps or less). For larger relay or solenoid coils, or larger inductive loads, place an MOV in parallel with the R-C snubbers across the load. Kit # 300-NK4 contains 2 MOV's and one snubber for use with 120 VAC loads.
3. Keep low voltage wires (transmitters, sensors) and high voltage wires (line power, relay output) physically separated in different bundles when routing them in your system. When high voltage and low voltage wires must cross, cross them at a 90° angle. Never allow them to run side by side in parallel to one another.
4. Use shielded wire on low voltage wires, grounding the shield, or when possible use grounded metal conduit to route the low voltage wires.
5. Use ungrounded thermocouples in systems that involve ignition spark gaps. You may also use additional process variable input filtering on systems that use these devices. If the spark gap is given a sufficient low impedance return path, these items will most likely not be necessary.

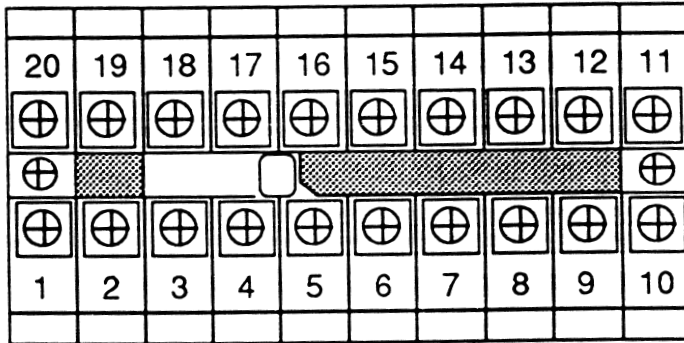

Rear Terminal Connections

- |  |  |
|--|--|
| 1. Line (L1)   | 12. Alarm (Relay, SSR, or SSR Drive Module) Output #2-       |
| 2. Neutral (L2/N)                                      | 13. Analog (Retransmission or Loop Power #2 Module) Output + |
| 3. Earth Ground  | 14. Analog (Retransmission or Loop Power #2 Module) Output - |
| 4. Alarm (Relay) Output #1-                            | 15. Loop Power or Excitation Output +                        |
| 5. Alarm (Relay) Output #1+                            | 16. Loop Power or Excitation Output -                        |
| 6. Unused  | 17. RS-485 Communications +                                  |
| 7. Unused  | 18. RS-485 Communications -                                  |
| 8. RTD 3rd Leg   | 19. Digital Input +  |
| 9. PV-   | 20. Digital Input -  |
| 10. PV+  |  |
| 11. Alarm (Relay, SSR, or SSR Drive Module) Output #2+ |  |

## About the Mechanical Relays (Alarm 1 or Alarm 2)

The alarm 2 output may have an R-C snubber network to help filter voltage transients created during the switching process. If you are using the alarm 2 mechanical relay to switch a low current (high impedance) load less than 1 milliamp, then this network may have to be removed. With very light loads there is enough leakage current that will flow through the snubber capacitors (~500  $\mu$ A) leaving the load always in the ON condition. Both the Alarm 1 and Alarm 2 outputs have normally-open and normally-closed jumper positions. Set the jumper to select the desired relay action.

## Rear Contact Wiring

**NOTE:** For rear contact switching, a dry contact, TTL logic or an open-collector transistor may be used.

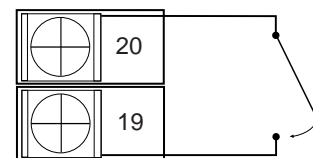

## SSR Drive Output Wiring (Alarm 2)

Many SSR's (Solid State Relays) which switch typical 120/240 VAC loads have two terminals that use ~3 to 30 VDC to turn the device on. Our SSR Drive output is ~17 VDC when active and ~0.3 VDC when inactive. This is suitable for switching most of the SSR's on the market. Be sure to set the option board jumper to the normally-open (NO) position when using an SSR drive output.

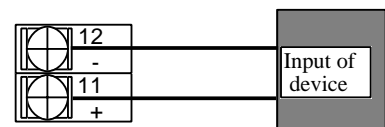

## SSR Output Wiring (Alarm 2)

Be sure to set the option board jumper to the normally-open (NO) position when using an SSR output.

## Communications Wiring

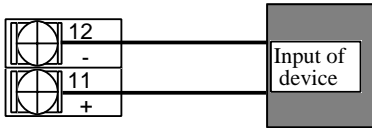

A twisted shielded pair of wires should be used to interconnect the host and field units. Belden #9414 foil shield and #8441 braid shield 22-gauge wire are acceptable for most applications. The foil shielded wire has superior noise rejection characteristics. The braid shielded wire has more flexibility. Note that the maximum recommended length of the RS 485 line is 4000 feet. Termination resistors are required at the host and the last device on the line. Some RS 485 cards/converters already have a terminating resistor. We recommend using an RS-232/RS-485 converter (products no. 500-485). The communication protocol is asynchronous bidirectional half-duplex, hence the leads are labeled "Data +" and "Data -".

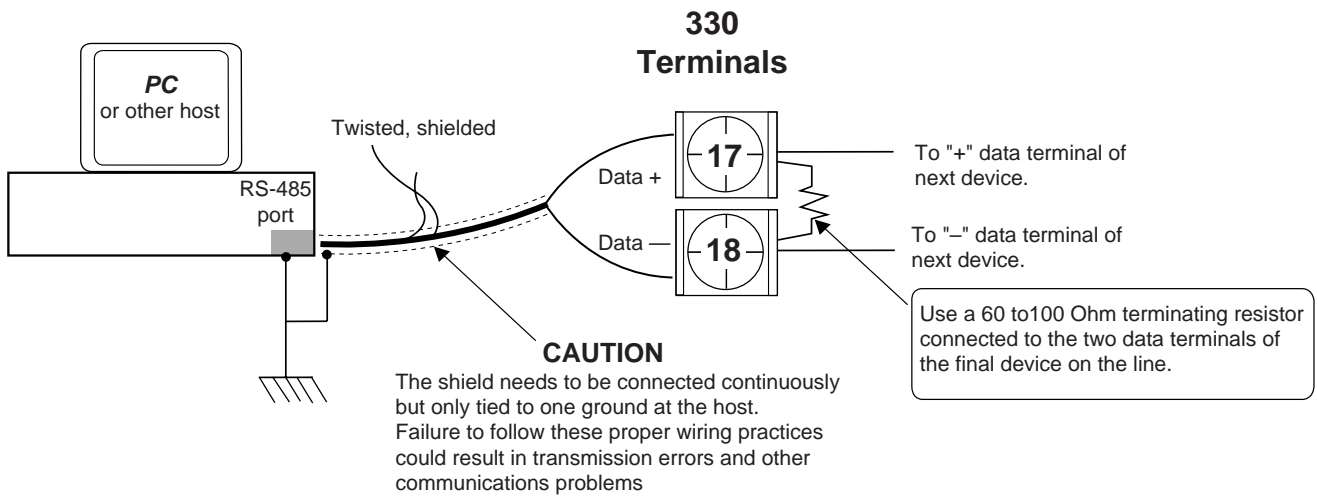

## Thermocouple Input Wiring

**Note:** Refer to thermocouple manufacturer's specification for positive and negative color code.

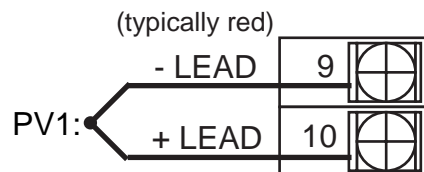

## RTD Input Wiring (100 ohm platinum, JIS or DIN curves)

### 2-wire RTD

Use a jumper wire between terminals 8 and 9. If the lead runs are longer than 10 feet, use a small value resistor (the resistance of one of the lead wires to the RTD) instead of a jumper wire.

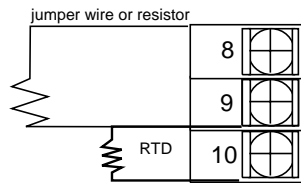

### 3-wire RTD

On a 3-wire RTD, the two wires of the same color should be wired to terminals 8 and 9.

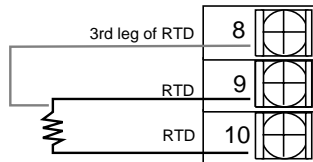

### 4-wire RTD

The fourth leg should not be attached. The two wires of the same color should be wired to terminals 8 and 9.

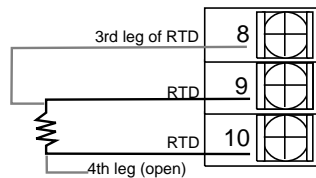

## Voltage/Current Input Wiring

Voltage and Milliamp Inputs use the terminals shown in the diagrams below. When using milliamp inputs, the 330 may power a transmitter using loop power.

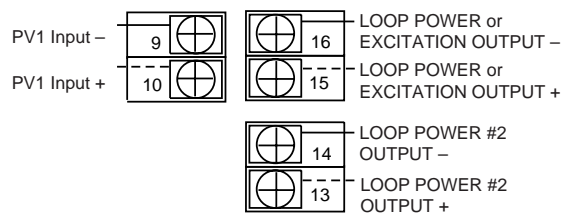

## Voltage/Current Input Operation

Volt/milliamp inputs give you many range selections: 4-20 mA, 0-20 mA, 1-5V, 0-5V, +/- 30mV, 0-30mV, 0-60mV, or 0-100mV. This is software selectable. When the input is within the selected input range, the proper process variable is displayed. As the input falls out of range, a two stage error message is displayed. The first stage flashes an estimated process variable based on the out-of-range input. As the input falls further out of range, the display stops flashing and displays -Hi- or-Lo-.

### 4 to 20mA, 1 to 5 Volt or +/- 30mV

#### Live Zero

These inputs are the most common choice for most applications. They are typically used with transmitters.

### 0 to 20mA, 0 to 5 Volt, 0 to 30mV, 0 to 60mV, or 0 to 100mV (true unipolar)

#### Dead Zero

These inputs are used with transmitters, strain gauges, or other devices with a zero based output.

## PV Display Values for each Volt/Milliamp Input Type

DISPLAY	INPUT	INPUT	INPUT
	Current(4-20mA)	Voltage(1-5V)	Voltage(+/-30mV)
Normal	3.68 to 20.32	0.92 to 5.08	-31.20 to 31.20
Flashes	3.60 to 3.68	0.90 to 0.92	-31.50 to -31.20
	20.32 to 20.40	5.08 to 5.10	31.20 to 31.50
"-Lo-"	Below 3.60	Below 0.90	Below -31.50
"-Hi-"	Above 20.40	Above 5.10	Above 31.50

DISPLAY	INPUT	INPUT	INPUT	INPUT	INPUT
	Current(0-20mA)	Voltage(0-5V)	Voltage(0-30mV)	Voltage(0-60mV)	Voltage(0-100mV)
Normal	0 to 20.40	0 to 5.10	0 to 30.60	0 to 61.20	0 to 102.00
Flashes	20.40 to 20.50	5.10 to 5.125	30.60 to 30.75	61.20 to 61.50	102.00 to 102.50
"-Hi-"	Above 20.50	Above 5.125	Above 30.75	Above 61.50	Above 102.50

## Hardware Set Up

Hardware configuration determines the available outputs as well as output relay status. The 330R Monitor comes from the factory set with the following:

- All specified modules and options installed (for details, refer to the Order Code in the first section of this manual).
- Process variable input set to accept a milliamp input.
- Alarm relay outputs set to normally open.

## Accessing and Changing Jumpers

Depending on the model number ordered, the 330 will come with one or two boards. the 330R000 is shipped with one board. The 330R with any additional specified options will be shipped with two boards. The alarm relay output jumper is set at the factory to normally open (N.O.). This jumper, or in the case of units with two boards, are at the end of the boards and are easy to access.

You will need this equipment:

- Needle-nose pliers (optional)
- Phillips screwdriver (#2)
- Wrist ground strap

1. With power off, loosen the two front screws and remove them.
2. Slide the chassis out of the case by pulling firmly on the bezel.
3. Locate the jumper to change. See Figure 1.
4. Using the needle-nose pliers (or fingers), lift the jumper and place it in the alternative position marked on the board.

Figure 1

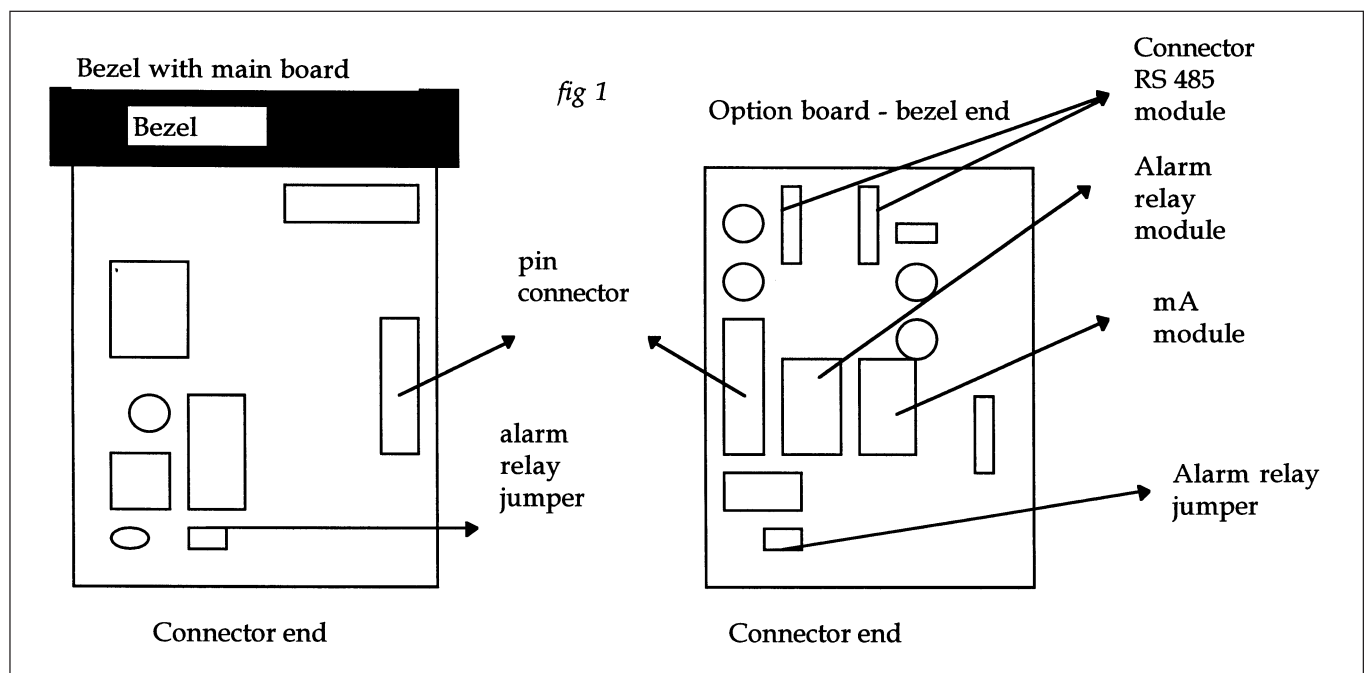

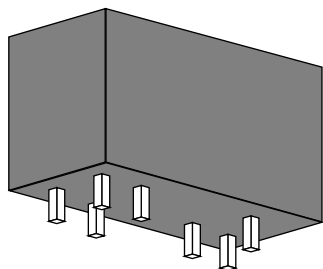

Module Representation

## Adding or Changing Option Boards or Output Modules

The basic 330R has provisions for adding up to 4 different option boards. Three of these option boards may be shipped with different output modules; these may also be added in the field. These modules are the same as those used in the 535 Series of controllers. To add or change output boards or modules, please do the following:

You will need this equipment:

- Needle-nose pliers (optional)
- Phillips screwdriver (#2)
- Wrist ground strap

1. With power off, loosen the two front screws, and remove them.
2. Slide the chassis out of the case by pulling firmly on the bezel.
3. If unit has two boards, one main and one option, carefully pry the board apart at the connector, (see Figure 2) until it separates approximately 1/2 inch.
4. Carefully detach the *option* board from the two fingers holding it to the instrument bezel. Under most circumstances, there is no need to remove the main board from the instrument bezel.
5. The available "A", "B", and "C" option board each have the provision for a plug-in analog output module and second alarm output module (see the ordering code for details.) See Figure 1 for module positioning.
6. The connector for the RS 485 module is on the option board. (see Figure 1.)
7. Remove modules by clipping the tie wrap holding it in place and replacing it with a different module. Use a new tie wrap to secure the module in place.
8. Reassemble the 330R by carefully lining up and pressing together the connector pins between the main and option board, then snap the option board to the fingers securing it to the bezel.

Figure Figure 2

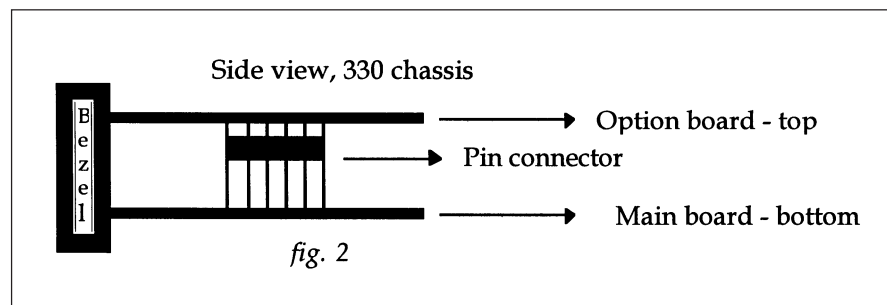

## 330R Display Modes, Menus and Security Levels

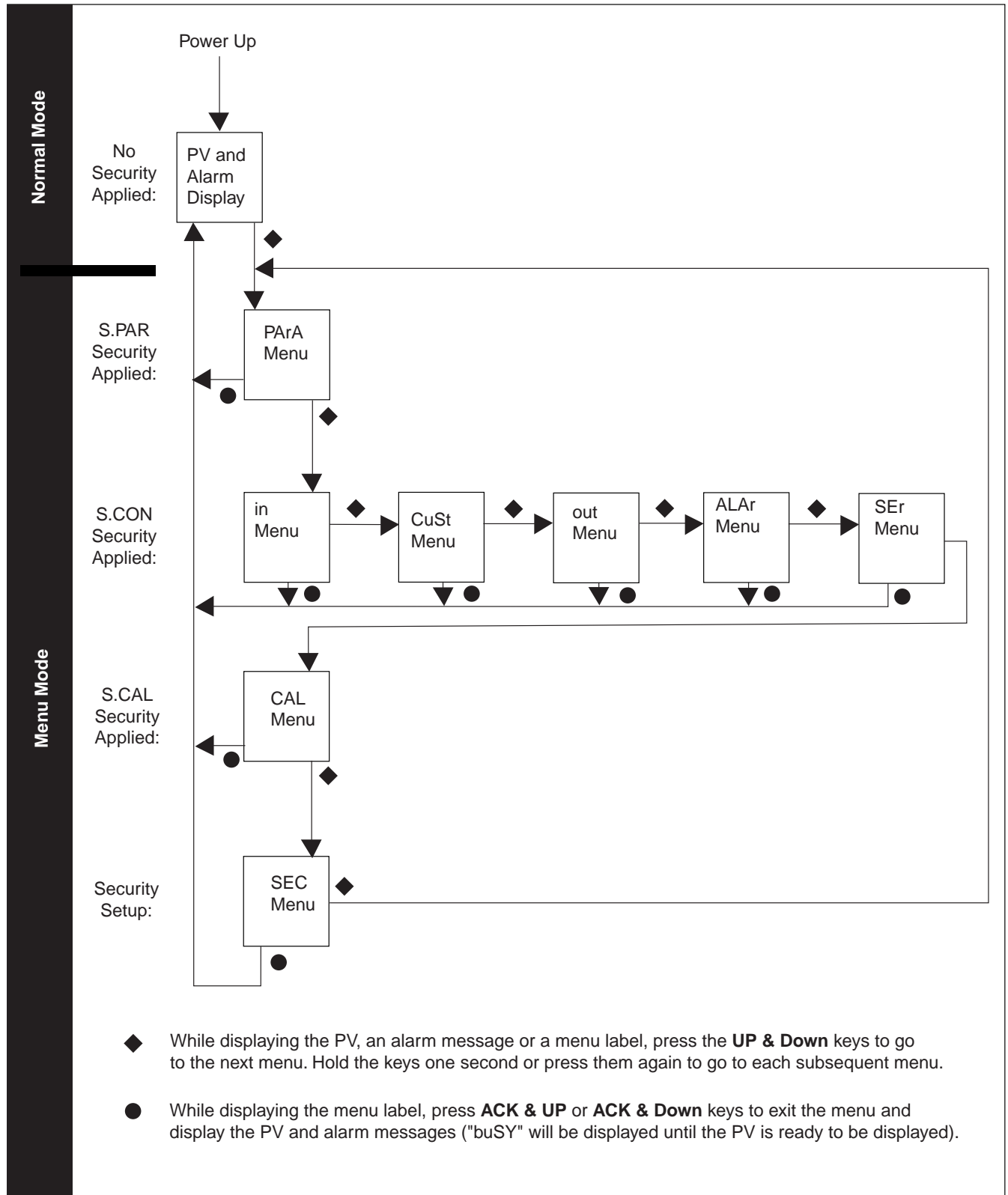

## Configuration (Menu Mode)

The 330 has settable parameters that allow you to customize the monitor for a particular application. These parameters are changed when initially installing the instrument or if your application changes. You should review these parameters prior to operating the instrument for the first time. Operating functions and alarms are described in greater detail on pages 17 to 23.

While displaying the PV, an alarm message or a menu label, press the UP & DOWN keys to go to the next menu; hold the keys 1 sec. to go to each subsequent menu. While displaying a menu label, press the ACK & UP or ACK & DOWN keys to exit the menu and display the PV; then “buSY” will be displayed temporarily. Press the up or down keys to modify a value.

### 1 “PArA” Menu

Label	Description	Appears if	Values	Default	Notes
PEAk	PV peak (max) value	Always appears	-999 to 9999	-999	Press UP & DOWN to reset; uses dP dec. pt.
VALY	PV valley (min) value	Always appears	-999 to 9999	9999	Press UP & DOWN to reset; uses dP dec. pt.
AHi1	Alarm 1 high setpoint	AC-1 is High or HiLo	-999 to 9999	0	Uses dP decimal point
ALo1	Alarm 1 low setpoint	AC-1 is lo or HiLo	-999 to 9999	0	Uses dP decimal point
AHi2	Alarm 2 high setpoint	AC-2 is High or HiLo	-999 to 9999	0	Uses dP decimal point
ALo2	Alarm 2 low setpoint	AC-2 is lo or HiLo	-999 to 9999	0	Uses dP decimal point

### 2 “in” Menu

Label	Description	Appears if	Values	Default	Notes
InPt	PV input	Always appears	tc.uP,tc.dn, rtd, Curr, VoLt	Curr	No jumpers
Type	PV input type	Always appears	J tc, E tc, k tc, b tc, n tc, r tc, S tc, t tc, g tc, C tc, PL.tc, din, JiS, 4-20, 0-20 1-5, 0-5, +-.03, 0-.03, 0-.06, 0-.10	4-20	Selections for thermocouple rtd, Curr or volt are available according to the value of inPt
dEg	PV degree units or rtd	inPt is tc.uP, tc.dn kELV	FAhr, CELS,	FAhr	
Lin	PV linearization	inPt is Curr or Volt	oFF, Sqrt, CuSt	oFF	Selections for square or custom linearization are available.
CV	CV multiplier (used to calculate flow PV from differential pressure)	Lin is Sqrt	oFF or 0.1 to 999.9	oFF	Flow PV formula: $CV * \sqrt{(PV \text{ input})}$
dP	PV decimal point	inPt is rtd, Curr or VoLt	nnnn, nnn.n, nn.nn, n.nnn	nnnn	rtd allows nnnn or nnn.n only
PVLo	PV low input value or VoLt and Lin is not CuSt	inPt is Curr	-999 to 9999	0	Uses dP decimal point

<b>PVHi</b>	PV high input value	inPt is Curr or VoLt and Lin is not CuSt	-999 to 9999	1000	Uses dP decimal point
<b>FiLt</b>	PV input filter	Always appears	oFF or 0.1 to 120.0	oFF	In tenths of a second
<b>OfSt</b>	PV input offset	Always appears	-999 to 9999	0	Uses dP decimal point
<b>gAin</b>	PV gain applied using PV input range	Always appears	0.100 to 9.999	1.000	
<b>rcon</b>	Rear contact (digital input) configuration.	Option is installed	Ack, rSt, Lock	Ack	

### 3 "CuSt" Menu

Label	Description	Appears if	Values	Default	Notes
<b>in-1</b>	Custom linearization input point 1	inPt is Curr or VoLt and Lin is CuSt	Minimum input value	4.00	Dependent on inPt and typE selections
<b>PV-1</b>	Custom linearization PV point 1	inPt is Curr or VoLt and Lin is CuSt	-999 to 9999	0	Uses dP decimal point
<b>in-2</b>	Custom linearization input point 2	inPt is Curr or VoLt and Lin is CuSt	>= in-1	in-1 value	Dependent on inPt and typE selections
<b>PV-2</b>	Custom linearization PV point 2	inPt is Curr or VoLt and Lin is CuSt	-999 to 9999	PV-1 value	Uses dP decimal point
<b>in-n</b>	Custom linearization input point n (n=3 to 14)	inPt is Curr or VoLt and Lin is CuSt	>= in-(n-1)	in-(n-1) value	Dependent on inPt and typE selections
<b>PV-n</b>	Custom linearization PV point n (n=3 to 14)	inPt is Curr or Volt and Lin is CuSt	If PV-2<PV-1 then PV-n<= PV-(n-1); else PV-n>=PV-(n-1)	PV-(n-1) value	Uses dP decimal point
<b>in15</b>	Custom linearization input point 15	inPt is Curr or VoLt and Lin is CuSt	Maximum input value	20.00	Dependent on input and typE selections
<b>PV15</b>	Custom linearization PV point 15	inPt is Curr or VoLt and Lin is CuSt	If PV-2<PV-1 then PV15<= PV14; else PV15>=PV14	PV14 value	Uses dP decimal point

### 4 "out" Menu

Label	Description	Appears if	Values	Default	Notes
<b>rLY1</b>	1st alarm output relay action	Always appears	oFF, on	on	Selects on/off if alarm 1 active
<b>rLY2</b>	2nd alarm output relay action	Option is installed	oFF, on	on	Selects on/off if alarm 2 active
<b>rEtr</b>	Retransmission output assignment	Option is installed	oFF, 4-20, 20-4, 0-20, 20-0	oFF	Selects retransmission(mA) output
<b>rELo</b>	Retransmission low range value	rEtr is 4-20, 20-4, 0-20 or 20-0	-999 to 9999	0	Uses dP decimal pt.
<b>rEHi</b>	Retransmission high range value	rEtr is 4-20, 20-4, 0-20 or 20-0	-999 to 9999	1000	Uses dP r decimal pt.

# Configuration

## 5 “ALAr” Menu

Label	Description	Appears if	Values	Default	Notes
AC-1	Alarm 1 type	Always appears	oFF, High, Lo, HiLo	oFF	
Aou1	Alarm 1 output	AC-1 is not oFF	nonE,rLY1,rLY2	rLY1	
Lch1	Alarm 1 latching	AC-1 is not oFF	oFF, on	on	
Ack1	Alarm 1 acknowledgement	AC-1 is not oFF	oFF, on	on	
Adb1	Alarm 1 deadband	AC-1 is not oFF	1 to 9999	2 decimal pt.	Uses dP
APu1	Alarm 1 power-up state	AC-1 is not oFF	PV, AL, noAL	PV	
AC-2	Alarm 2 type	Always appears	oFF, High, Lo, HiLo	oFF	
Aou2	Alarm 2 output	AC-2 is not oFF	nonE,rLY1,rLY2	rLY2	
Lch2	Alarm 2 latching	AC-2 is not oFF	oFF, on	on	
Ack2	Alarm 2 acknowledgement	AC-2 is not oFF	oFF, on	on	
Adb2	Alarm 2 deadband	AC-2 is not oFF	1 to 9999	2 decimal pt.	Uses dP
APu2	Alarm 2 power-up state	AC-2 is not oFF	PV, AL, noAL	PV	

## 6 “SEr” Menu

Label	Description	Appears if	Values	Default	Notes
StAt	RS-485 station address	Comm. board is installed	0 to 99	0	
BAud	RS-485 baud rate selection	Comm. board is installed	1200, 2400, 4800, 9600, 19.2k	9600	
Crc	RS-485 CRC-16 selection	Comm. board is installed	oFF, on	on	

## 7 “CAL” Menu

To execute a calibration step, press the UP and DOWN keys simultaneously while the value is displayed. To skip a calibration step, press the ACK key. The parameters are:

Label	Description	Appears if	Display Values	Default	Calibration Procedure
PVLC	Calibrates PV low input	Always appears	0.000	0.000 (V, mA or ohms)	Short PV+ (and 3rd leg if PV is an rtd) to PV-, then press the UP and DOWN keys simultaneously
PVHC	Calibrates PV high input	PVLC calibration was just completed	Value can be adjusted using the UP and DOWN Keys	3.634V, 87.66V, 45.99mV, 18.07mV, 19.20mA, 300.0 Ohms, or 150.0 ohms	Apply the displayed V, mA, or ohms value to PV (and short the 3rd leg input to PV-if PV is an rtd), then press the UP and DOWN keys simultaneously

<b>CJLo</b>	Calibrates cold junction sensor low input	inPt is tc.uP or tc.dn	0.000	0.000 (V)	Short PV+ to PV-, then press the UP and DOWN keys simultaneously
<b>CJHi</b>	Calibrates cold junction sensor high input	CJLo calibration was just completed	Value can be adjusted using the UP and DOWN keys	0.898V	Apply the indicated voltage to PV, then press the UP and DOWN keys simultaneously
<b>tc.in</b>	Calibrates cold junction compensation for t/c inputs	inPt is tc.uP or tc.dn	Default value	680F, 360C or 633k	Apply t/c calibrator to PV using the correct t/c wire type and the displayed temp. setting, then press the UP and DOWN keys simultaneously
<b>out0</b>	Calibrates the retrans. 0mA output	rEtr is 0-20 or 20-0	0.000	0.000 (mA)	Attach mA meter to mA output and: 1) press the UP or DOWN key to adjust the display to match the meter reading; 2) press the UP and DOWN keys simultaneously; 3) repeat steps (1) and (2) until the displayed 0mA output value is within tolerance
<b>out4</b>	Calibrates the retrans. 4mA output	rEtr is 4-20 or 20-4	4.000	4.000 (mA)	Attach mA meter to mA output and: 1) press the UP or DOWN key to adjust the display to match the meter reading; 2) press the UP and DOWN keys simultaneously; 3) repeat steps (1) and (2) until the displayed 4mA output value is within tolerance

# Configuration

<b>ou20</b>	Calibrates the retrans. 20mA output	rEtr is 4-20, 20-4, 0-20 or 20-0	20.00	20.00 (mA)	Attach mA meter to mA output and: 1) press the UP or DOWN key to adjust the display to match the meter reading; 2) press the UP and DOWN keys simultaneously; 3) repeat steps (1) and (2) until the displayed 20mA output value is within tolerance
-------------	-------------------------------------	----------------------------------	-------	------------	--

8 "SEC" Menu					
Label	Description	Appears if	Values	Default	Notes
<b>CodE</b>	Security code which enables security override for 1 minute	Always appears	-999 to 9999	0	
<b>S.PAr</b>	PARA menu security enable/disable	Always appears	oFF, on	oFF	
<b>S.Con</b>	CONF menu security enable/disable	Always appears	oFF, on	oFF	
<b>S.CAL</b>	CAL menu security enable/disable	Always appears	oFF, on	oFF	

## OPERATION

### Operator Interface

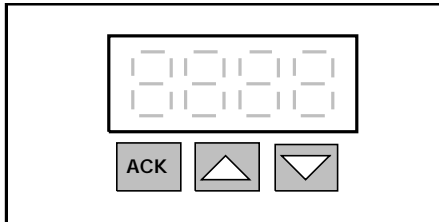

FEATURE	FUNCTION
Display	Process variable (PV), alarm messages or menu parameters



#### LED Indicators:



 ON when Alarm 1 or Alarm 2 is active and acknowledgeable



 **normal mode:** ACKnowledge (release) alarms  
**menu mode:** select the next parameter

 **menu mode only:** increase parameter value

 **menu mode only:** decrease parameter value



 and  Go to the next menu in menu mode, reset the displayed peak or valley value, or execute a calibration step

 and  Exit menu mode and return to normal mode

 and  Exit menu mode and return to normal mode

#### Peak/Valley Values

The 330 stores both the maximum (peak) and minimum (valley) PV values in memory. These values may be displayed by entering the Parameter Menu.

Each value may be reset to the current process variable value by holding the  key and then pressing the  key while viewing the value. The rear contact can be configured to reset the peak/valley values. Closing the contact will reset both values simultaneously to the current PV value as selected by the rcon parameter.

## Alarm Operation

The alarms may be configured for latching type, latching sequence, output assignment, relay state, deadband and power up state. Placement of the trip points and dead bands can create a number of different alarm types.

### Alarm Indication

A tripped alarm is indicated when the “AL 1” or “AL 2” message is displayed.

### Alarm Dead Band

Configurable alarm dead bands prevent alarm relays from fluttering on and off after entering an alarm condition and settling back down near the alarm set points. After entering alarm condition, alarm relay will not de-energize until PV, PV, or PV2 reading falls an additional dead band unit from the alarm set point.

### Alarm Output Assignment

Selects whether the alarm activates one of the relay outputs (rLY1 or rLY2).

### Alarm Acknowledgement

Alarms are acknowledgeable if the ACK key is lit. Alarms are acknowledged by pressing . When acknowledged, the alarm relay changes state to its normal condition and the alarm message is cleared. If both alarms are active, Alarm 1 is acknowledged prior to Alarm 2.

### Alarm Latching

Latch = OFF, ACK = ON: Alarm message is displayed and relay changes state when PV enters alarm condition. Alarm message is cleared and relay returns to normal state when leaving alarm condition. Alarm can be released by pressing .

Latch = ON, ACK = ON: Alarm message is displayed and relay changes state when PV enters alarm condition. Alarm message remains active and relay remains in current state after leaving alarm condition until  is pressed at which point the alarm message is cleared and the relay changes state.

atch = OFF, ACK = OFF: Alarm message is displayed and relay changes state when PV enters alarm condition. Alarm message is cleared and relay returns to normal state when leaving alarm condition. Pressing  will not release alarm.

Latch = ON, ACK = OFF: Acts as a limit device. Alarm message is displayed and relay changes state when PV enters alarm condition. Alarm message remains active and relay remains in current state after leaving alarm condition until  is pressed. However, the alarm cannot be acknowledged while in the alarm condition.

### Alarm Power Up

Defines the state of the alarm when the instrument is powered up. The instrument can be configured to never go into alarm upon power up, to always go into alarm or to only go into alarm if the process variable values warrant.

## Alarm Operation Charts

The five charts that follow represent samples of how alarms can be configured to work. You may set yours up similarly.

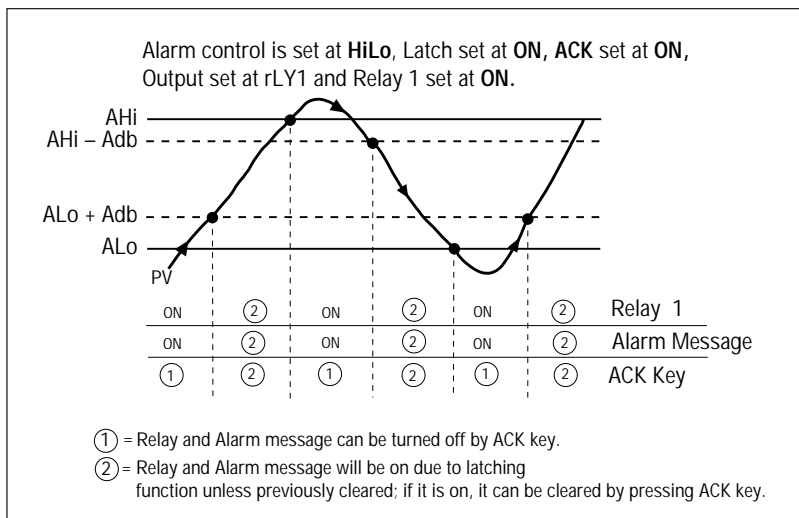
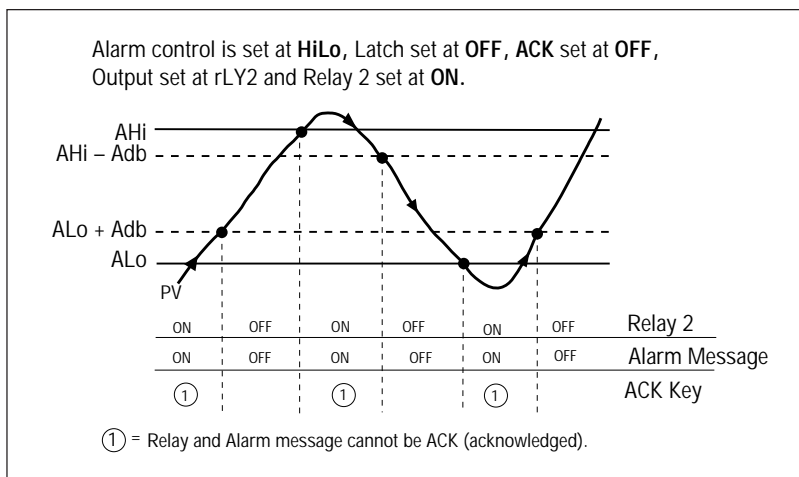
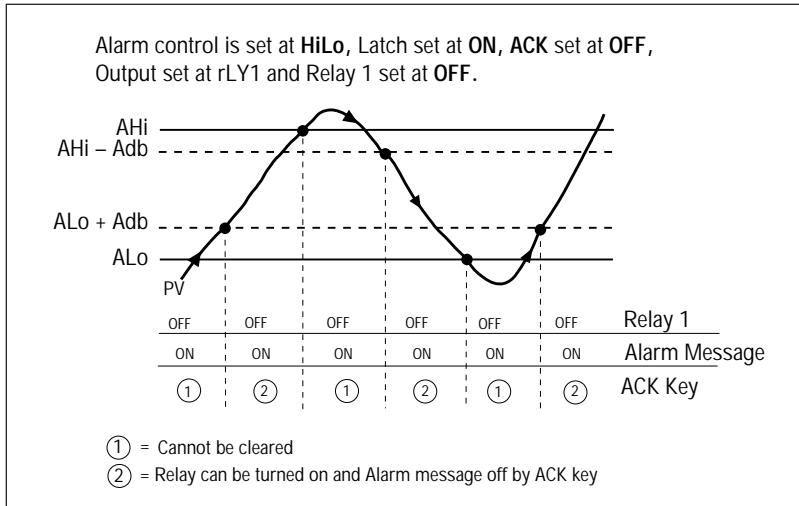

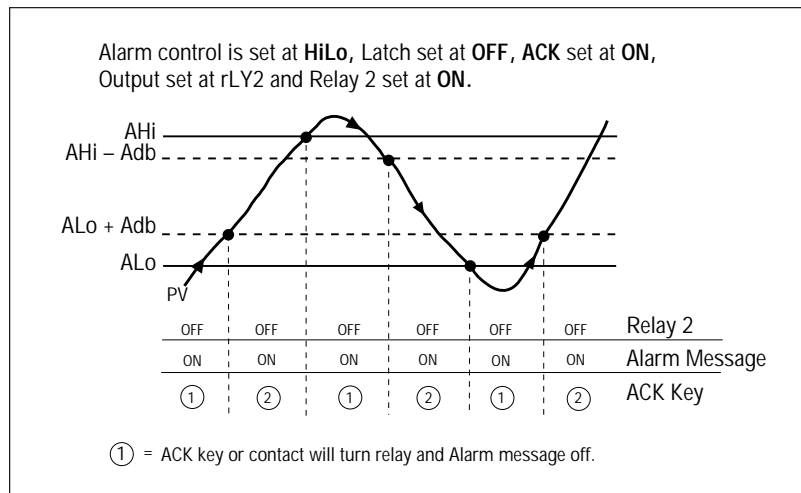
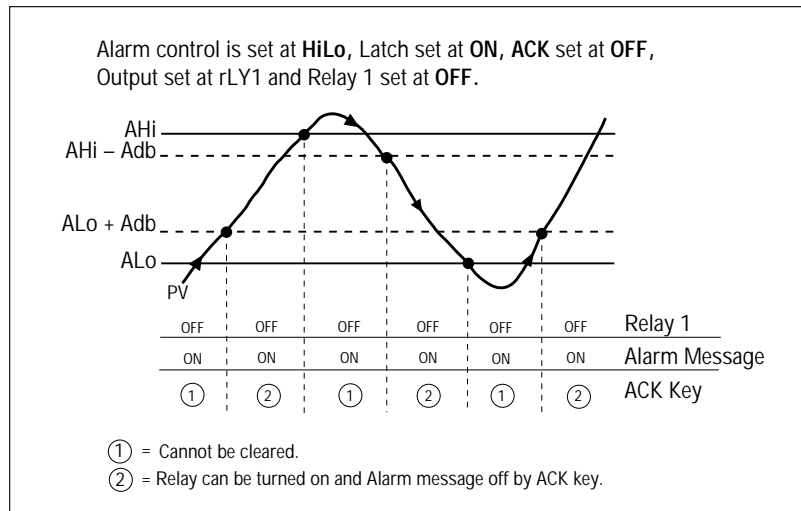

## Input Linearization

### Square Root

Many flow transmitters generate a non-linear signal corresponding to the flow being measured. To linearize this signal for use by the 330, the square root of the signal must be calculated. The 330 has the capability to perform this square root linearization prior to display and retransmission. To utilize this feature, you must set the Lin parameter to Sqrt.

$$PV = PVLo + [(PVHi - PVLo) \sqrt{(\text{input} - \text{low}) / (\text{high} - \text{low})}]$$

Example: Lin = Sqrt, Cv=Off, PVHi = 5000, PVLo = 0, inPt = Volt, typE = 1-5, dP=nnnn

(high = 5, low = 1)

If the PV input = 2 Volts,

$$PV = 0 + (5000 - 0) \sqrt{(2 - 1) / (5 - 1)} = 2500$$

If the PV input = 3 Volts,

$$PV = (5000 - 0) \sqrt{(3 - 1) / (5 - 1)} = 3535.$$

## Square Root and CV (Flow Coefficient)

The 330 can measure flow rate through a valve or other constriction using a differential pressure transducer input, square root linearization, and the valve's CV (flow coefficient) value at a given valve position. For materials with a specific gravity of 1 (i.e. water), flow is measured using the following formula:

$$PV = CV \sqrt{(PVHi - PVLo)(input-low)/(high-low) + PVLo}$$

Example: inPt = Curr, tYPE = 4-20, Lin = Sqrt, CV = 50.0, PVHi =30.0, PVLo = 0.0, dP=nnn.n (high = 20mA, low = 4mA)

If the PV input = 5mA,

$$PV = 50.0 \sqrt{(30.0-0.0)(5-4)/(20-4) + 0.0} = 68.5$$

If the PV input = 8mA,

$$PV = 50.0 \sqrt{(30.0-0.0)(8-4)/(20-4) + 0.0} = 136.9$$

## Custom Linearization (PV Voltage/current input only)

Custom Linearization allows you to take virtually any nonlinear signal and linearize it using a 15-point straight line approximation curve. Typical applications are linearizing signals from nonlinear transducers and displaying/controlling volume based on level readings for irregularly-shaped tanks and bins. To define the function, you must enter data point pairs. Each of these consists of an input value (in-1 through dEg5) and an output value (PV-1 through PV15). Each data point pair defines a single point along the function line. You may enter up to 15 point-pairs to define the nonlinear function.

The 330 treats the region between points as a straight line (see figure below). It can calculate the output value for any input by finding the two points the input value lies between. This is called interpolation. Since it takes two points to define a line, you must enter at least two point pairs to use the custom linearization feature.

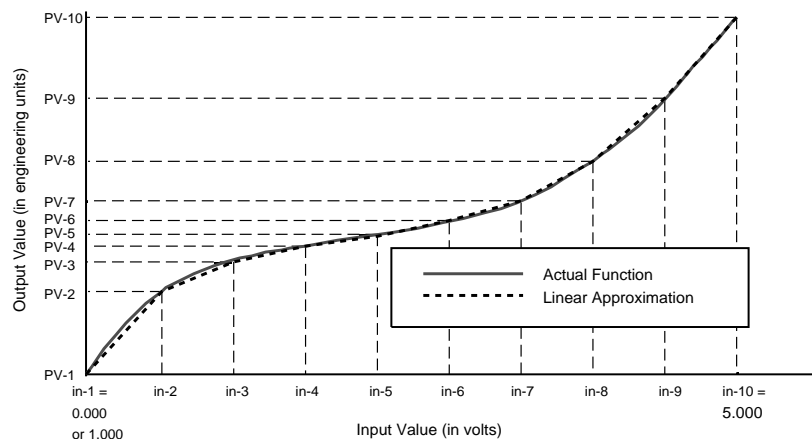

**Note:** Custom Linearization is available for any volt or milliamp PV input.

## Security

If security is applied to a menu (using the S.PAr, S.Con or S.CAL parameter in the SEC menu) then that menu cannot be accessed until the correct security code is entered.

For example, if security is applied to a particular menu and both the UP and DOWN keys are pressed to access that menu, “CodE” will be displayed for 2 seconds. Then “0” will be displayed. This value must be modified (using the UP and DOWN keys) to match the “CodE” value previously selected in the SEC menu.

Then after 2 seconds of key inactivity the security code value will be checked. If an erroneous security code value is entered, the menu will not be displayed (the PV value will be displayed instead).

If 6264 is entered, then all security parameters will be set to default values (thus turning security off) and the menu will be displayed.

If the correct security code is entered (rather than 6264), security will be temporarily disabled and the menu will be displayed. After 60 seconds of key inactivity, security will be re-armed. (In other words, if no keys are pressed for 60 seconds, the security code will need to be re-entered before the menu can be accessed again).

## Troubleshooting / Service

Symptom	Possible Cause	Solution
<b>THERMOCOUPLE</b>		
<b>"-in-" Readout</b>	Wrong thermocouple type configured.	Check input configuration for proper thermocouple type.
	Wrong input terminals used.	Check input wiring.
	Extension wire used is not compatible with thermocouple.	Match extension wire with thermocouple wire.
	Defective thermocouple.	Replace thermocouple.
<b>Wrong Readout</b>	Reverse polarity.	Check input wiring.
	Wrong thermocouple configured in input configuration.	Configure correct input type.
<b>RTD</b>		
<b>"-in-" readout</b>	Wrong input terminals used. Defective RTD.	Check input wiring. Replace RTD.
<b>Wrong Readout</b>	Wrong RTD configured in input configuration.	Configure correct input type.
	Lead impedance exceeds specification (100 ohms per lead max). Leads must have equal resistance.	Place unit closer to RTD or resistance. Use RTD transmitter when distance between RTD and controller is greater than 1000 feet.
<b>VOLTAGE/CURRENT</b>		
<b>"-Hi-" or "-Lo-"</b>	Wrong input terminals used.	Check input wiring.
	Voltage or mA input level exceeds or does not meet specification.	Recalibrate transmitter output to meet specifications.
	Defective transmitter.	Replace transmitter.
<b>Wrong Readout</b>	Reverse polarity.	Check input wiring.
<b>ERROR-MESSAGES</b>		
<b>"E.DAT" or "E.A2D" Readout</b>	Initialization error.	Call factory for assistance.
<b>"E.CHE" Readout</b>	Checksum error during power up.	Call factory for assistance.
<b>Instrument resets, erratic PV reading memory loss, reversion to defaults, or failure to detect output signal change.</b>	Electrical noise problem beyond the filtering capability of the monitor.	Refer to following section on Electrical Noise Solutions.

**Note:** If after checking the solution you still experience difficulty with your unit, please contact either your Moore Industries representative or one of our application engineers.

## Electrical Noise Solution

### Contact/Load Suppression:

When the instrument relays are used to switch another relay coil, contactor, solenoid or some other inductive load, large voltage spikes are created back on the AC power line. When excessive, these voltage spikes can disrupt the operation of this product, causing it to reset as if power had just been applied. These types of loads should have suppression devices right across the load, at the load. We recommend the use of an R-C snubber. Additionally, an MOV should be placed across loads greater than 0.25 amps.

When a relay opens an inductive load, there is energy that will form around the contacts. This is a form of electrical noise that could disrupt the product if severe enough and damage the relay contacts as well. Internal to the product is an R-C snubber across each relay contact to help absorb some of this energy. An additional snubber mounted to the terminal block may improve contact life and reliability when switching large inductive loads.

## Specifications

### Accuracy

All accuracy ratings are at reference conditions (at least 30 min. at 25 °C)

Thermocouple Inputs:	± 0.15% of span typical ± 1 digit
RTD Inputs:	± 0.10% of span typical ± 1 digit
Millivolt/Voltage/Current Inputs:	± 0.05% typical ± 1 digit
Resolution:	0.004% of span typical

### Architecture

The 330 hardware can be configured as follows:

**Inputs:** One universal process variable input is standard. Available options include digital input.

**Outputs:** Up to 3 outputs are available, plus transmitter loop power or strain gauge excitation voltage.

**RS-485 Communications:** Available as an option.

### Process Variable Input

Universal input. Any input type may be selected in the field via the front panel or communications.

Thermocouples	Range °F	Range °C
B	104 to 3301	40 to 1816
E	-454 to 1832	-270 to 1000
J	-346 to 1832	-210 to 1000
K	-418 to 2500	-250 to 1371
N	-328 to 2372	-200 to 1300
R	32 to 3182	0 to 1750
S	32 to 3182	0 to 1750

Specifications and information subject to change without notice.

T	-328 to 752	-200 to 400
W (G)	32 to 4172	0 to 2300
W5 (C)	32 to 4172	0 to 2300
Platinel II	-148 to 2550	-100 to 1399
<b>RTD's</b>	<b>Range °F</b>	<b>Range °C</b>
100 ohm Pt. (DIN)	-328 to 1562	-200 to 850
	-328.0 to 545.0	-200.0 to 285.0
100 ohm Pt. (JIS)	-328 to 1202	-200 to 650
	-328.0 to 545.0	-200.0 to 285.0

## Current, Voltage, or Millivolt Signals

Milliamps DC	4 to 20, 0 to 20
Volts DC	1 to 5, 0 to 5
Millivolts DC	-30 to 30, 0 to 30, 0 to 60, 0 to 100

## Input Signal Failure Protection

Thermocouple inputs are configurable for upscale or downscale burnout; RTD inputs fail upscale if any leg is broken.

## Input Impedance

Current Input:	100 ohms
Voltage Input:	10 Mohms typical
RTD or	
Thermocouple Input:	100 Mohms typical
Millivolt Input:	100 Mohms typical

## Input Filter

A single pole lowpass filter with selectable time constants from 0.0 to 120.0 seconds is available.

## Input Linearization

Square root linearization is available. Each thermocouple or RTD input is automatically linearized. The PV input may use 15 point user-definable linearization if it is a voltage, millivolt or milliamp input.

## Contact Input

External dry contact input or open-collector transistor input for alarm acknowledgement, peak/valley reset or keypad lockout. Isolated from process variable input and digital circuitry.

## Memory

Non-volatile EEPROM.

## Transmitter Loop Power or Excitation Voltage

Loop power capacity is 40mA at 24VDC. Excitation voltage is 10VDC  $\pm$  2% into at least 175 ohms.

## Sampling Rate

Input sampled 12 times per second (every 83.3 msec).

## Digital Displays

Green LED display is 4-digit, 7 segment, 0.56" (14.3mm) high. Range is -999 to 9999. Assignable decimal position with current, voltage, or millivolt inputs.

## Mounting

Panel-mounted with a depth of 6.14 inch (156 mm).

## Wiring Connections

Screw terminals on the rear of case.

## Power Consumption

24 VA maximum.

## Weight

Approx. 1.0 lbs (0.45 kg).

## Ambient Temperature

**Operative Limits:** 32 to 122 °F (0 to 50°C)

**Storage:** -40 to 185 °F (40 to 85°C)

## Relative Humidity

10 to 90% at 40°C (104°F), non-condensing.

## Analog Retransmission Output

Either 0-20mA, 4-20mA, 20-4mA or 20-0mA (front panel selectable) into a load up to 1000 ohms.

Accuracy  $\pm$  20 $\mu$  A @25 °C.

## Mechanical relays

SPDT electromechanical relay. Resistive load rated at 5 amps at 120/240 VAC. Normally open or normally closed selection is made by jumper.

## Solid state relay (triac) module

Resistive load rated at 1 amp at 120/240 VAC.

## DC logic (SSR drive) module

"ON" voltage is 17 Vdc (nominal). "OFF" voltage is less than 0.5 Vdc. (Current limited to 40mA.)

## Voltage

90 to 250 VAC

## Frequency

50/60  $\pm$  2 Hz

## Serial Communications

Isolated, bidirectional, two wire, half-duplex RS-485 serial interface. 1,200 to 19,200 baud rate. Selectable CRC data checking. Protocol allows access to every operation and configuration parameter.

## Construction

Case:	Polylac PA-765 ABS, 94V-0 Rated
Bezel:	GE LEXAN <sup>®</sup> 500, 94V-0 Rated
Keys:	Silicone rubber with diffusion printed graphics
NEMA Rating:	Front panel rated NEMA 4X when instrument is properly installed

## Security

Two levels of access are available: restricted and full.  
A user-configurable code is used to enter the full access level.

## Calibration

Comes fully calibrated from the factory. Field calibration can be easily performed in the field with a precision multimeter and input simulator. Process variable offset and gain factors are provided to correct for sensor errors.



## RETURN PROCEDURES

To return equipment to Moore Industries for repair, follow these four steps:

1. Call Moore Industries and request a Returned Material Authorization (RMA) number.

### Warranty Repair –

If you are unsure if your unit is still under warranty, we can use the unit's serial number to verify the warranty status for you over the phone. Be sure to include the RMA number on all documentation.

### Non-Warranty Repair –

If your unit is out of warranty, be prepared to give us a Purchase Order number when you call. In most cases, we will be able to quote you the repair costs at that time. The repair price you are quoted will be a "Not To Exceed" price, which means that the actual repair costs may be less than the quote. Be sure to include the RMA number on all documentation.

2. Provide us with the following documentation:
  - a) A note listing the symptoms that indicate the unit needs repair
  - b) Complete shipping information for return of the equipment after repair
  - c) The name and phone number of the person to contact if questions arise at the factory
3. Use sufficient packing material and carefully pack the equipment in a sturdy shipping container.
4. Ship the equipment to the Moore Industries location nearest you.

The returned equipment will be inspected and tested at the factory. A Moore Industries representative will contact the person designated on your documentation if more information is needed.

The repaired equipment, or its replacement, will be returned to you in accordance with the shipping instructions furnished in your documentation.

### WARRANTY DISCLAIMER

THE COMPANY MAKES NO EXPRESS, IMPLIED OR STATUTORY WARRANTIES (INCLUDING ANY WARRANTY OF MERCHANTABILITY OR OF FITNESS FOR A PARTICULAR PURPOSE) WITH RESPECT TO ANY GOODS OR SERVICES SOLD BY THE COMPANY. THE COMPANY DISCLAIMS ALL WARRANTIES ARISING FROM ANY COURSE OF DEALING OR TRADE USAGE, AND ANY BUYER OF GOODS OR SERVICES FROM THE COMPANY ACKNOWLEDGES THAT THERE ARE NO WARRANTIES IMPLIED BY CUSTOM OR USAGE IN THE TRADE OF THE BUYER AND OF THE COMPANY, AND THAT ANY PRIOR DEALINGS OF THE BUYER WITH THE COMPANY DO NOT IMPLY THAT THE COMPANY WARRANTS THE GOODS OR SERVICES IN ANY WAY.

ANY BUYER OF GOODS OR SERVICES FROM THE COMPANY AGREES WITH THE COMPANY THAT THE SOLE AND EXCLUSIVE REMEDIES FOR BREACH OF ANY WARRANTY CONCERNING THE GOODS OR SERVICES SHALL BE FOR THE COMPANY, AT ITS OPTION, TO REPAIR OR REPLACE THE GOODS OR SERVICES OR REFUND THE PURCHASE PRICE. THE COMPANY SHALL IN NO EVENT BE LIABLE FOR ANY CONSEQUENTIAL OR INCIDENTAL DAMAGES EVEN IF THE COMPANY FAILS IN ANY ATTEMPT TO REMEDY DEFECTS IN THE GOODS OR SERVICES, BUT IN SUCH CASE THE BUYER SHALL BE ENTITLED TO NO MORE THAN A REFUND OF ALL MONIES PAID TO THE COMPANY BY THE BUYER FOR PURCHASE OF THE GOODS OR SERVICES.

ANY CAUSE OF ACTION FOR BREACH OF ANY WARRANTY BY THE COMPANY SHALL BE BARRED UNLESS THE COMPANY RECEIVES FROM THE BUYER A WRITTEN NOTICE OF THE ALLEGED DEFECT OR BREACH WITHIN TEN DAYS FROM THE EARLIEST DATE ON WHICH THE BUYER COULD REASONABLY HAVE DISCOVERED THE ALLEGED DEFECT OR BREACH, AND NO ACTION FOR THE BREACH OF ANY WARRANTY SHALL BE COMMENCED BY THE BUYER ANY LATER THAN TWELVE MONTHS FROM THE EARLIEST DATE ON WHICH THE BUYER COULD REASONABLY HAVE DISCOVERED THE ALLEGED DEFECT OR BREACH.

### RETURN POLICY

For a period of thirty-six (36) months from the date of shipment, and under normal conditions of use and service, Moore Industries ("The Company") will at its option replace, repair or refund the purchase price for any of its manufactured products found, upon return to the Company (transportation charges prepaid and otherwise in accordance with the return procedures established by The Company), to be defective in material or workmanship. This policy extends to the original Buyer only and not to Buyer's customers or the users of Buyer's products, unless Buyer is an engineering contractor in which case the policy shall extend to Buyer's immediate customer only. This policy shall not apply if the product has been subject to alteration, misuse, accident, neglect or improper application, installation, or operation. THE COMPANY SHALL IN NO EVENT BE LIABLE FOR ANY INCIDENTAL OR CONSEQUENTIAL DAMAGES.



*The Interface Solution Experts • [www.miinet.com](http://www.miinet.com)*

United States • [info@miinet.com](mailto:info@miinet.com)  
Tel: (818) 894-7111 • FAX: (818) 891-2816  
Australia • [sales@mooreind.com.au](mailto:sales@mooreind.com.au)  
Tel: (02) 8536-7200 • FAX: (02) 9525-7296

Belgium • [info@mooreind.be](mailto:info@mooreind.be)  
Tel: 03/448.10.18 • FAX: 03/440.17.97  
The Netherlands • [sales@mooreind.nl](mailto:sales@mooreind.nl)  
Tel: (0)344-617971 • FAX: (0)344-615920

China • [sales@mooreind.com.cn](mailto:sales@mooreind.com.cn)  
Tel: 86-21-68406724 • FAX: 86-21-50623585  
United Kingdom • [sales@mooreind.com](mailto:sales@mooreind.com)  
Tel: 01293 514488 • FAX: 01293 536852